



Applications

- Power Converters
- Lighting Control
- DC Motor Control and Drives
- Heat and temperature control

Features

- International standard package
- High Surge Capability
- Simple Mounting

Internal Circuit

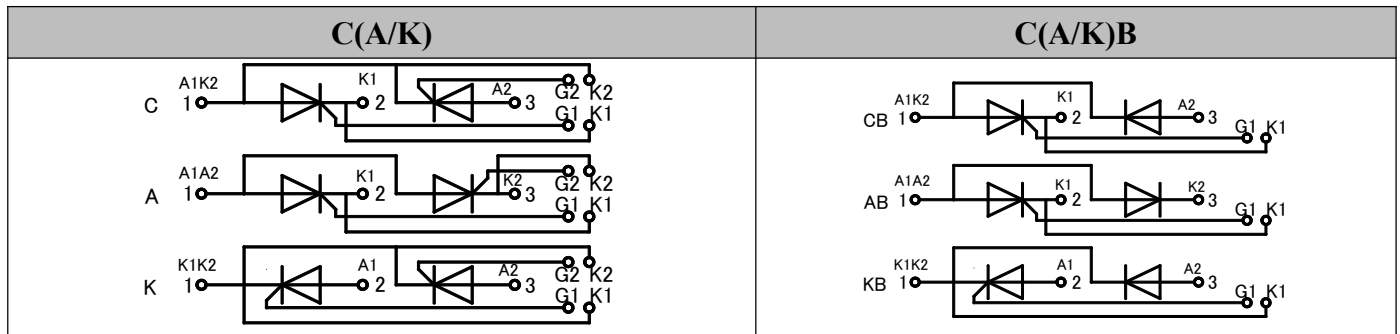

Blocking - Off State

TYPE		V _{DRM} /V _{RRM}	V _{DSM} /V _{RSM}	Units
MT160C(A/K)28AT2	MT160C(A/K)B28AT2	2800	2900	V
MT160C(A/K)30AT2	MT160C(A/K)B30AT2	3000	3100	V
MT160C(A/K)32AT2	MT160C(A/K)B32AT2	3200	3300	V
MT160C(A/K)34AT2	MT160C(A/K)B34AT2	3400	3500	V
MT160C(A/K)36AT2	MT160C(A/K)B36AT2	3600	3700	V

Maximum Ratings

Symbol	Conditions	Values	Units
I _{TAV}	Sine 180°; T _c =85°C	160	A
I _{TSM}	T _{VJ} =125°C t=10ms, sine	3900	A
I ² t	T _{VJ} =125°C t=10ms, sine	76000	A ² s
Visol	a.c.50HZ;r.m.s.;1min,I _{iso} :2mA(MAX)	4000	V
T _{vj}		-40 to 125	°C
T _{stg}		-40 to 125	°C
M _t	To terminals(M6)	6±15%	Nm
M _s	To heatsink(M6)	6±15%	Nm
di/dt	T _{VJ} = T _{VJM} , V _{DM} ≤2/3V _{DRM} , I _{GM} =1.5A t _r ≤1.5μs	100	A/μs
dv/dt	T _{VJ} = T _{VJM} , 2/3V _{DRM} , linear voltage rise	1000	V/μs
Weight	Module(Approximately)	380	g

Thermal Characteristics

Symbol	Conditions	Values	Units
R _{th(j-c)}	per chip	0.14	°C/W
R _{th(c-h)}	per chip	0.07	°C/W



Electrical Characteristics

Symbol	Conditions	Values			Units
		Min.	Typ.	Max.	
V_{TM}	$T=25^{\circ}C$ $I_{TM}=480A$			2.5	V
I_{RRM}/I_{DRM}	$T_{VJ}=T_{VJM}$, $V=V_{RRM}$, $V=V_{DRM}$			30	mA
V_{TO}	$T_{VJ}=T_{VJM}$			0.88	V
r_T	$T_{VJ}=T_{VJM}$			2.3	m Ω
V_{GT}	$T_{VJ}=25^{\circ}C$, $V_D=12V$, $R_L=3\Omega$	0.8		2.5	V
I_{GT}	$T_{VJ}=25^{\circ}C$, $V_D=12V$, $R_L=3\Omega$	30		150	mA
I_L	$T_{VJ}=25^{\circ}C$, $V_D=12V$, $R_L=3\Omega$			1000	mA
I_H	$T_{VJ}=25^{\circ}C$, $V_D=12V$, $R_L=3\Omega$	20		150	mA
V_{GD}	$T_{VJ}=T_{VJM}$, $V_{DM}=67\%V_{DRM}$	0.2			V

Performance Curves

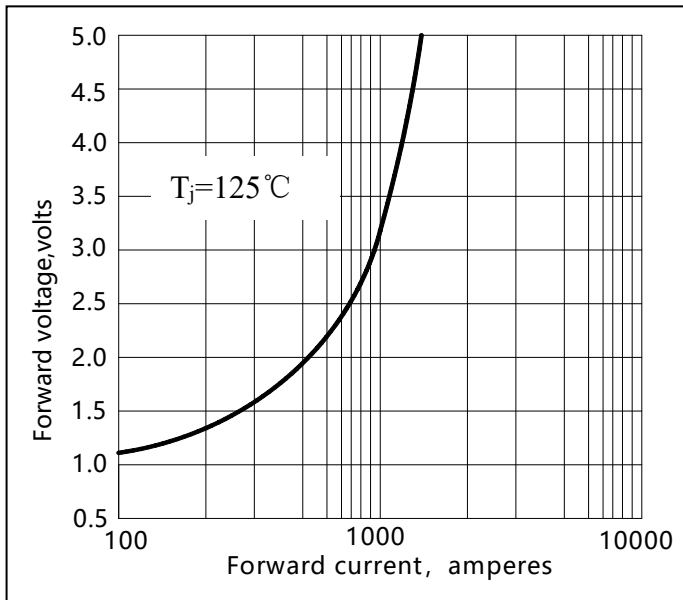

Fig1. Peak On-state Voltage Vs Peak On-state

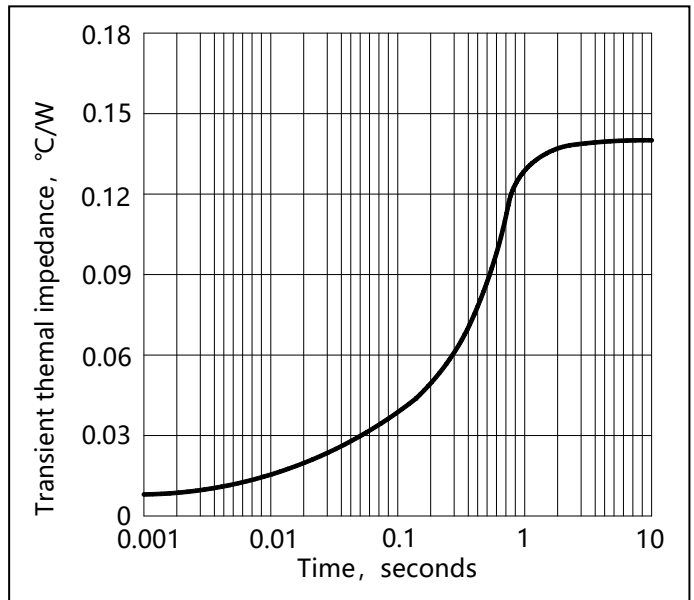

Fig2. Max. junction To case Thermal Impedance Vs Time

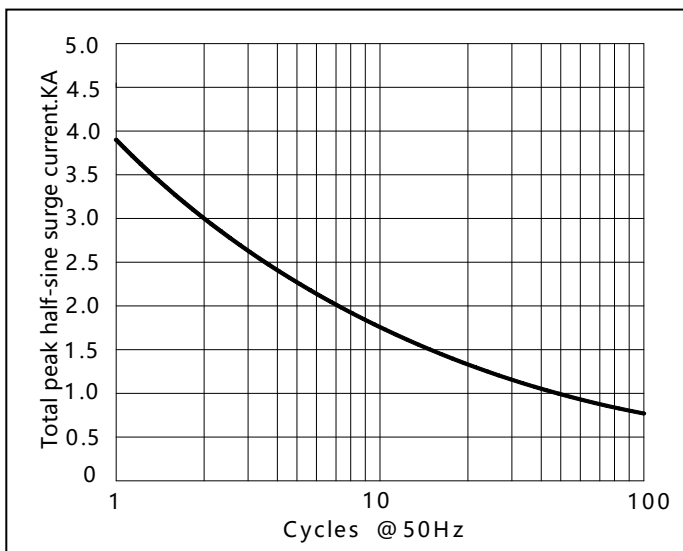

Fig3. Surge Current Vs Cycles

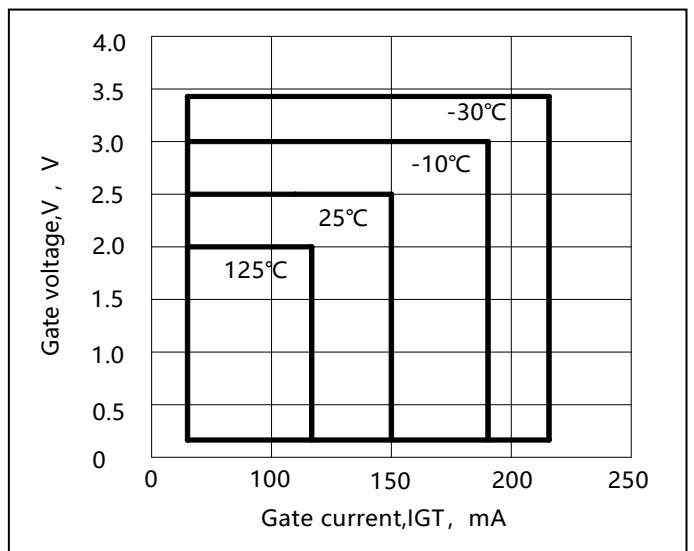

Fig4. Gate Trigger Zone Vs temperature

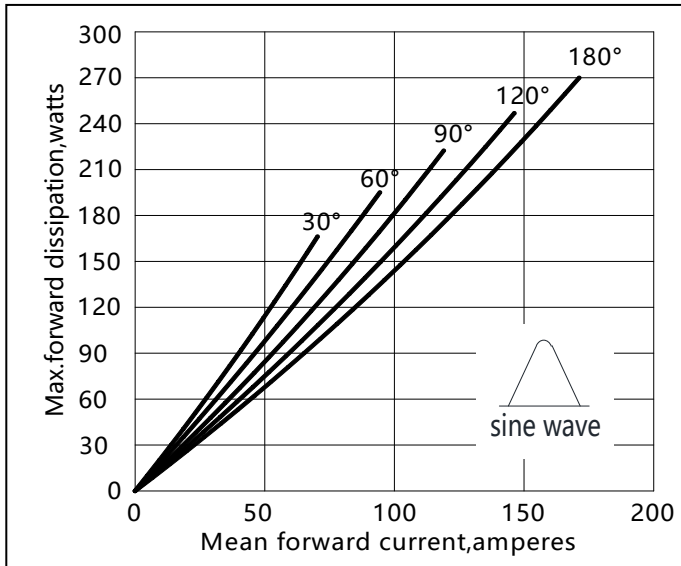

Fig5. Max. Power Dissipation Vs Mean On-state Current

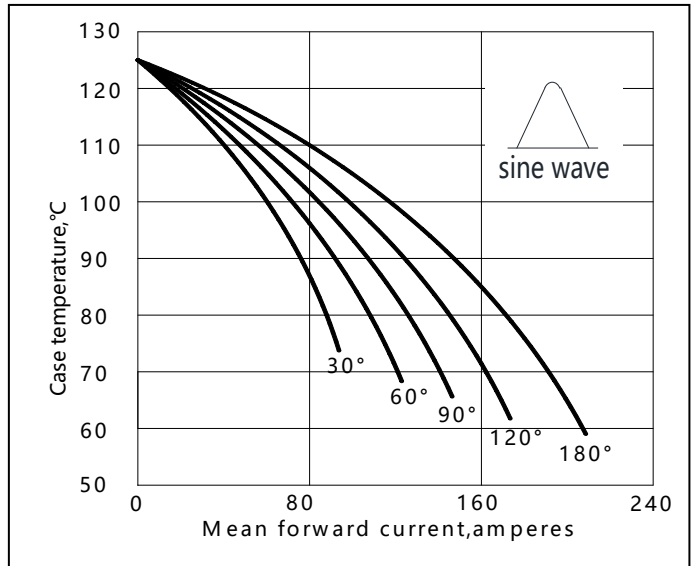

Fig6. Max case Temperature Vs Mean On-state Current

Package Outline Information

